

**Work-Integrated Learning Advisory Committee
Regular Meeting**

**Shin-Etsu Handotai America, Inc. (SEH-A) – 4111 N.E. 112th St., Vancouver, WA 98682
Henrietta Lacks Health and Bioscience (He La) High School – 9105 NE 9th St., Vancouver, WA
98664**

June 11, 2019

9:00 a.m.–4:00 p.m. (PST)

Members in Attendance: Representative Sharon Tomiko Santos
Senator Lisa Wellman
Rebecca Wallace, designee to the Superintendent of Public Instruction
Derek Jaques, representing K–12 CTE educators
Denise Reddinger, representing school counselors
Nova Gattman, designee of the Workforce Training Board (WTB)
Alice Madsen, representing Community and Technical Colleges
Maddy Thompson, representing the Office of the Governor

Members Absent: Representative Luanne Van Werven
Senator Ann Rivers

Staff to the Committee: Samantha L. Sanders, OSPI
Lance Wrzesinski, OSPI
Andrew Clancy, OSPI
Susan Locke, OSPI

Meeting Guests: Natalie Pacholl, Shin-Etsu Handotai America, Inc. (SEH-A)
Susan Dixon, Evergreen School District
Julie Tumelty, Henrietta Lacks Health and Bioscience (He La) High School
Representative Monica Stonier, House Democrats
Tim Knue, Washington Association for Career and Technical Education
Kelly Johnson, Hayes Freedom High School

Tour at Shin-Etsu Handotai America, Inc. (SEH-A):

The committee assembled at the SEH-A, at 9:00 a.m., for a tour of the facility led by Natalie Pacholl, Training Program Specialist for SHE-A. The committee had the opportunity to debrief at SEH-A subsequent to the tour from 10:00–11:00 a.m. Natalie shared that the company most values skills in their interns from the secondary system including knowledge of statistics, precise measurements, the ability to read MSDS sheets, basic communication skills, and technical reading skills. She spoke about some of the struggles with running the internship, noted that 350 interns have completed the program and 1/3 of those students have been hired with the company.

The committee then traveled to Henrietta Lacks Health and Bioscience High School for the committee meeting and tour of their facility.

Call to Order:

The meeting was called to order at 11:53 a.m. Advisory committee members and attendees were welcomed and invited to introduce themselves.

Working Lunch Presentation of Henrietta Lacks Health and Bioscience High School:

The committee was asked to consider/discuss the following:

- What is/has been the impact of work-integrated learning for students?
- Do you have ideas of how to improve the reach and quality of work-integrated activities?
- How do the experiences you are providing in work-integrated learning furthering academic expectations, including core academic credits for every student?
- What do you believe successful work-integrated learning experiences look like for students in the K-12 system?
- What are the barriers to being more successful in the number of students and quality of experiences?

Tour at Henrietta Lacks Health and Bioscience High School:

The committee and invited guests were assembled into two (2) groups to tour the facility, which was led by student ambassadors. The committee had the opportunity to ask questions of the student ambassadors during the tour and subsequently debrief with Julie Tumelty, Principal, Henrietta Lacks Health and Bioscience High School and Susan Dixon, CTE Director, Evergreen School District.

Spotlight on Existing Programs:

Henrietta Lacks Health and Bioscience (He La) High School, and Hayes Freedom High School:

- **Henrietta Lacks Health and Bioscience High School:** Julie Tumelty presented on Henrietta Lacks Health and Bioscience (He La) High School providing some history around He La, choice, and experience from her six (6) years in operations. She highlighted the program pathways with student ambassadors, included as Attachment "C" - Henrietta Lacks Health and Bioscience High School.
- **Hayes Freedom High School:** Kelly Johnson highlighted his work and emphasis on internships and community partnerships. There were referenced the presentation, included here as Attachment "D" - Hayes Freedom High School PowerPoint presentation.

Approval of Prior Minutes:

Derek called for a motion to approve the minutes of the May 1, 2019 meeting. Representative Santos moved to approve the minutes of May 1, 2019 as presented. The motion was seconded by Rebecca Wallace and carried unanimously. There was a request for future minute packets to contain conversations, but attachments from the previous meeting can be sent electronically and do not need to be printed in meeting materials. The committee agreed.

Updates on Proposed Policy Related to Committee Work (6):

Nova Gattman provided a brief update.

Updates on Career Connect Washington:

Lance discussed the overall progress for Career Connect Washington, noting that in the 5th quarter, had reached the following for its goals so far:

- 85% of target for Comprehensive Internships,
- 81% of target for Registered Youth Apprenticeships, and
- 95% of target for Adult Registered Apprenticeships.

The Career Connect Washington update is included as Attachment “E” – Quarterly Call presentation.

21st Century Leadership Skills:

Committee members were given a brief reminder about the intention of 21st Century Leadership Skills by Rebecca, and it was determined that a “deeper dive” was not needed at this time.

Future Meeting Planning:

The committee reviewed future meeting dates:

Meeting Date	Meeting Location	Meeting Time
Wednesday, August 21, 2019	OSPI, Olympia, WA (ZOOM available)	1–4 p.m.
Wednesday, October 9, 2019	Tentatively Eastern WA / Tri-Tech	9 a.m.–4 p.m.
Wednesday, December 11, 2019	TBD	TBD
Wednesday, February 12, 2020	TBD	TBD
Wednesday, April 15, 2020	TBD	TBD
Wednesday, June 10, 2020	TBD	TBD

Final Announcements and Conclusion of Meeting:

Derek requested completion of the Membership Response Form for future meeting guidance and adjourned the meeting at 4:02 p.m.

Attachments

- A. Committee Tasks
- B. WILAC Meeting 5 PowerPoint Presentation June 11 2019
- C. Hela High PowerPoint Presentation
- D. Hayes Freedom High School PowerPoint Presentation (To follow)
- E. Career Connect Washington PowerPoint Presentation

Work-Integrated Learning Advisory Committee Tasks



Attachment "B"

Work-Integrated Learning Advisory Committee

Tuesday, June 11, 2019

Office of Superintendent of Public Instruction
Chris Reykdal, State Superintendent

Introductions

- Staff/Guests: Name, organization
- Committee Members: Name, organization representing
Response: *What do you believe is the best way to remove perceived stigma related to work-related learning opportunities?*



OFFICE OF SUPERINTENDENT OF PUBLIC INSTRUCTION | *All students prepared for post-secondary pathways, careers, and civic engagement.* 06/11/2019 | 2

Approval of Minutes

- Motion for Approval



Agenda

Henrietta Lacks Health and Bioscience (He La) High School Tour

Spotlight on Existing Programs (5) (7) – Henrietta Lacks Health and Bioscience (He La) High School

- Q&A/Discussion

Break

Spotlight on Existing Programs (5) (7) – Hayes Freedom High School

- Q&A/Discussion

Updates on Proposed Policy Related to Committee Work (6)

- Policy Subcommittee report, co-chair, Nova Gattman

Career Connect Washington Update (3), Lance Wrzesinski

21st Century Leadership Skills review and discussion

Final Announcements and Conclusion of Meeting



Future Meetings

- **Meeting #6**
 - Wednesday, August 21, 2019
 - To be determined
 - To be determined
- **Meeting #7**
 - Wednesday, October 9, 2019
 - To be determined
 - To be determined



Shin-Etsu Handotai America, Inc. (SEH-A) Tour Discussion

- **Committee Talking Points**
 - What is/has been the impact of work-integrated learning for students?
 - Do you have ideas of how to improve the reach and quality of work-integrated activities?
 - How do the experiences you are providing in work-integrated learning furthering academic expectations, including core academic credits for every student?



Shin-Etsu Handotai America, Inc. (SEH-A) Tour Discussion

- **Committee Talking Points**

- What do you believe successful work-integrated learning experiences look liked for students in the K-12 system?
- What are the barriers to being more successful in the number of students and quality of experiences?



Henrietta Lacks Health and Bioscience (He La) High School Discussion

- **Tour led by student ambassadors**



Henrietta Lacks Health and Bioscience (He La) High School Discussion

• Committee Talking Points

- What is/has been the impact of work-integrated learning for students?
- Do you have ideas of how to improve the reach and quality of work-integrated activities?
- How do the experiences you are providing in work-integrated learning furthering academic expectations, including core academic credits for every student?



Henrietta Lacks Health and Bioscience (He La) High School Discussion

• Committee Talking Points

- What do you believe successful work-integrated learning experiences look like for students in the K-12 system?
- What are the barriers to being more successful in the number of students and quality of experiences?



Committee Discussion & Questions



Spotlight on Existing Programs (5) (7)

- **Henrietta Lacks Health and Bioscience (He La) High School**
 - Susan Dixon, CTE Director, Evergreen School District
 - Julie Tumelty, Principal, He La High School



Break

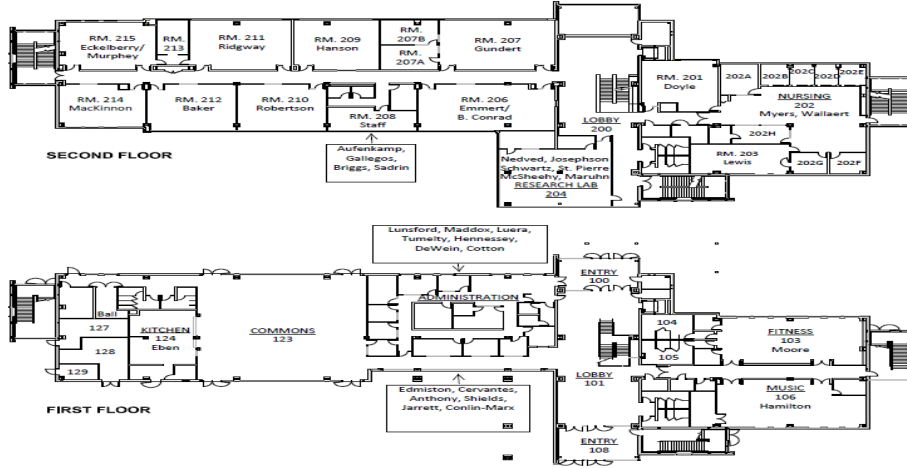

Spotlight on Existing Programs (5) (7)

- Hayes Freedom High School
 - Kelly Johnson, Internship Coordinator



Hayes Freedom High School

- Placeholder for slide deck



Committee Discussion & Questions



Updates on Proposed Policy Related to Committee Work

- Nova Gattman, Workforce Training and Education Coordinating Board



- Placeholder slide for Nova submission related to Leg. update



Career Connect Washington Update

- Lance Wrzesinski, Project Coordinator for Career Connect Washington



21st Century Leadership Skills review and discussion

- Washington Career and Technical Education – 21st Century Leadership Skills (handout)



Committee Discussion & Questions



Future Meeting Planning

- Wednesday, August 21, 2019
- Wednesday, October 9, 2019
- Wednesday, December 11, 2019
- Wednesday, February 12, 2020
- Wednesday, April 15, 2020
- Wednesday, June 10, 2020



Final Announcements

- Complete member response form



Staff Contact

Andrew Clancy
andrew.clancy@k12.wa.us
(360) 725-6249

Samantha L. Sanders
samantha.sanders@k12.wa.us
360-725-6259



Attachment "C"



Henrietta
Lacks



About Henrietta Lacks

Henrietta Lacks was born in 1920 in Roanoke, Virginia

Worked on the tobacco farm earning little

Henrietta met David Lacks, the father of her four children

The family moved to Baltimore to pursue a better life.



The Diagnosis

January 29th, 1951: Henrietta went to Johns Hopkins Hospital

A biopsy revealed she had cancer

The cells were immortal and could be cloned

Henrietta later died October 4th, 1951 at the age of 31

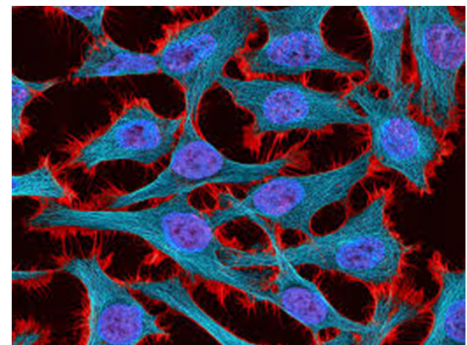

Henrietta's cells also known as HeLa Cells

The Use of the HeLa Cell

Research on

- Polio vaccine
- Cancer
- Effects of salmonella
- The effects of radiation and toxic substances
- HIV

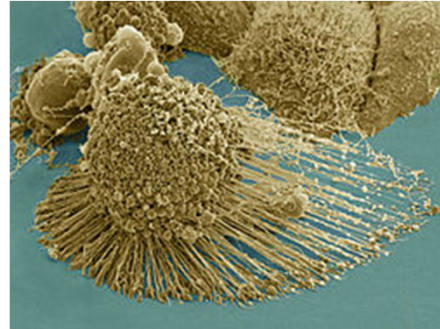

Henrietta's Family

Henrietta's family learns about HeLa cells' existence in 1973

The family's request for information on the cells were ignored

Considerable money was made off of HeLa cells

Her family has received zero compensation

Henrietta's story raised many ethical questions

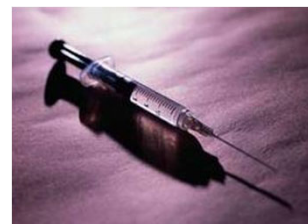

Overview of Henrietta Lacks High School

History of the school and initial planning

Our shared vision and mission

A health and bioscience school for all who apply

A culture of hope and a focus on equity

Unique offerings at HeLa - Programs of Study

*Pharmacy, Biotechnology, Biomedical Engineering, Public Health,
Nursing and Patient Services*

Student life - Henrietta Lacks High School

7 classes

-All core classes

-Freshman year: Medical Science, Chemistry

-Sophomore year: Anatomy and physiology, Biology(AP)

-Junior/Senior year: Program of study and internship

Pharmacology

Students learn about human pathologies and the medications used to treat them. The course curriculum is structured to run parallel to the organ systems covered in the nursing program.



Pharmacy Practice

Students learn work skills through practicing tasks commonly performed in community and institutional pharmacies.



Biotechnology - Cell & Molecular Biology

Biotechnology is the study of biological processes for the purpose of making a product or performing a task, **especially the genetic manipulation of microorganisms** to produce antibiotics, hormones, or other medical products.

- First year students focus on DNA.
- Second year students focus on proteins.

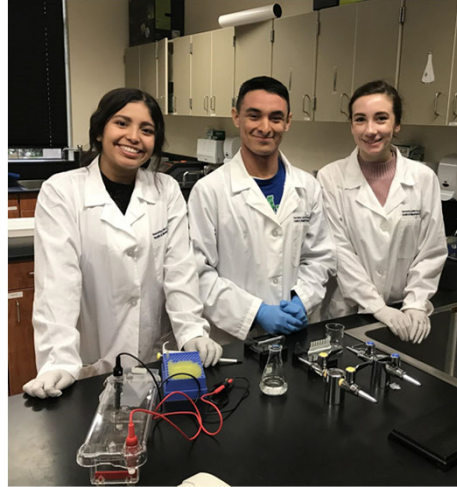

Using microscopes and staining techniques, students can identify bacteria

- Gram positive have a pink color
- Gram negative have a purple color

Student also observed HeLa cells and the chromosomes within the cells (lower right)

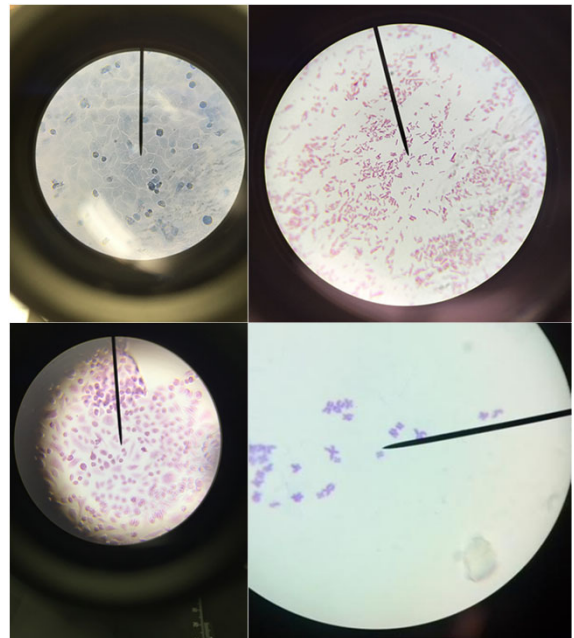

- Students separate DNA using an electrical current.
- Negatively charged DNA is attracted to the positive charge
- Small segments move faster than larger segments
- Plasmid Characterization
- DNA Analysis

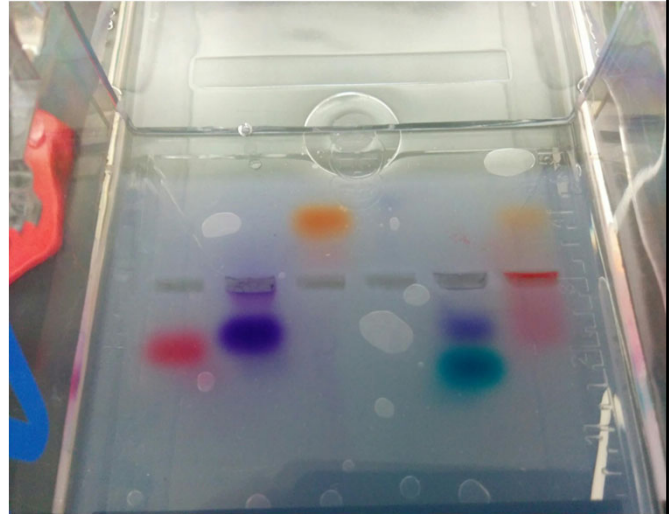

PUBLIC HEALTH

Erin Parr and Steven Deary

Public Health classes offered:

- * Epidemiology 1&2
- * Immunology
- * Physiology of Aging - new this year
- * Exercise Physiology
- * Advanced Physiology



"Public Health is the science and the art of preventing disease, prolonging life and promoting health through the organized efforts and informed choices of society, organizations and private communities and individuals"

-Charles Edward Amory Winslow 1920-

Epidemiology

Erin and Steven

Study of a branch of medicine that deals with possible control of diseases and other factors that relate to health



Which has more bacteria: your index finger or palm?

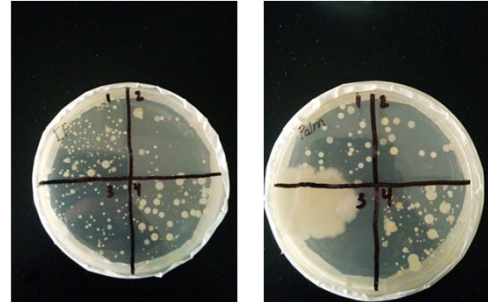

Other topics of study include...
Spread of disease, bacteria in the body, food borne illnesses

Immunology

Erin and Steven

Students will study the general properties of immune responses, cells and tissues of the immune system. Some other topics include immunodeficiency, AIDS, autoimmune disease and cancer.

im·mu·nol·o·gy

Immunology is a branch of biology that covers the study of immune systems in all organisms.

What is the immune system?

- The immune system, also known as the Lymphatic System, is a network of cells, tissues, and organs that work together to defend the body against attacks by "foreign" invaders.

Immune System

- Biomedical application of engineering principles and equipment
- Problem-solving related to real-world problems or applications
- Emphasis on programming and electronics
- Bioinformatics, Ethics, Muscle sensors

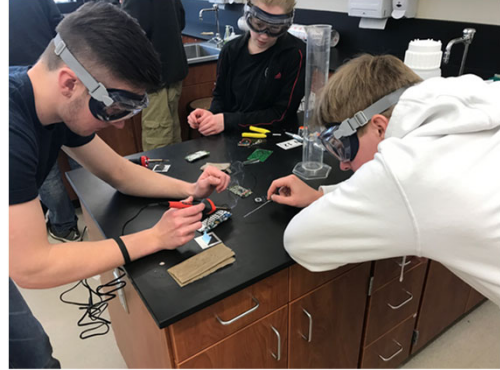

Biomedical Engineering (Year 2)

- Emphasis on 3D design
- Prosthetics design, Individualized healthcare, Diagnostic imaging

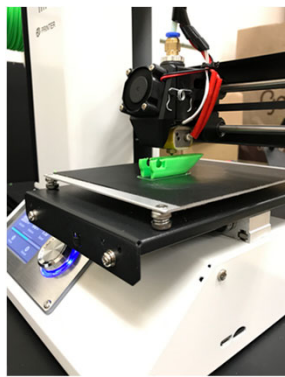
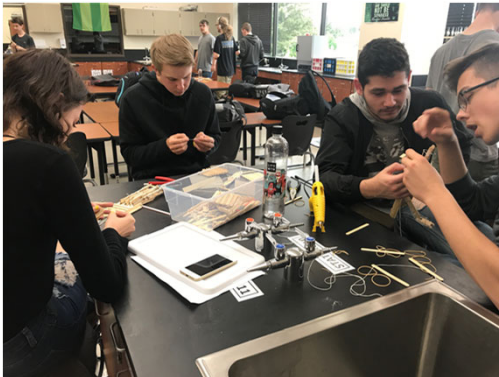

Nursing and Patient Services

- Focused on care and well-being of patients
- Washington State approved Certified Nursing Assistant training program
- State-of-the art Sims that reenact real life scenarios
- Externships during 2nd year



TOURS

Students will now be taking you on a tour of the building. Please form groups of 4 to 5 and a tour guide will join you.

THANKS FOR COMING!

Extra Curriculars

- HeLa offers six music groups
- Students participate in sports at their neighborhood high school
- Several clubs are offered such as: HOSA, NHS, Key Club, etc.



Attachment "D"

To Follow

Attachment "E"



QUARTERLY CALL
JUNE 6, 2019
2:00-3:00

Q4 to Q5 Change

Outcome	Q4	Q5	Difference	% Change
Comprehensive Internship	1680	2142	+462	+22%
Registered Youth Apprenticeship	34	44	+10	+23%
Adult Registered Apprenticeship	140	163	+23	+15%



STATEWIDE RESULTS (CUMULATIVE Q1-Q5)

Comprehensive Internship	2520	2142	85%
Registered Youth Apprenticeship	54	44	81%
Adult Registered Apprenticeship	170	163	95%



CCW Spring 2019 Feedback Survey Summary

In your CCW Regional Contracts project, rate how **challenging** or **successful** each of the following activities/elements were:

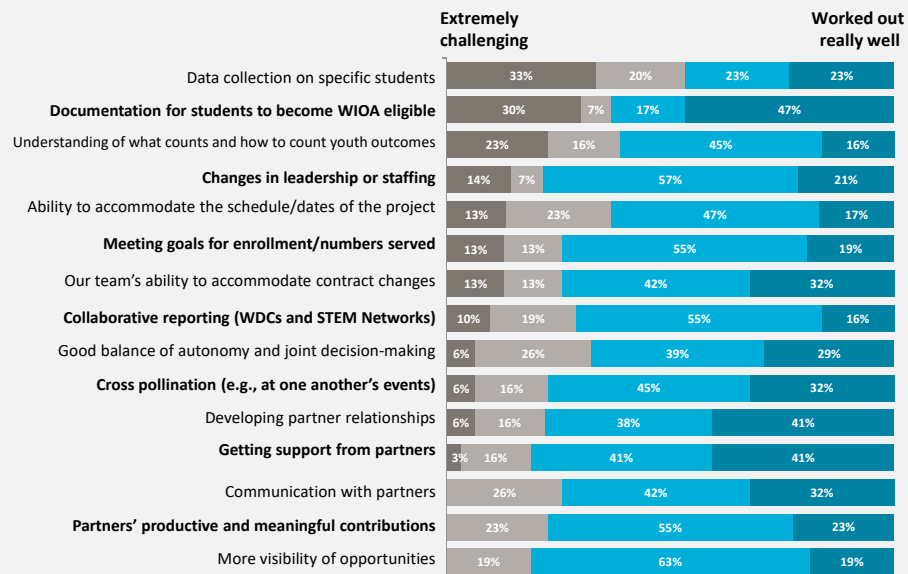

(items sorted by "Extremely challenging")

Survey Highlights

Challenges

- Data collection on specific students (tracking, etc.)
- Documentation for students to become WIOA eligible
- Understanding of what counts and how to count youth outcomes
- Accounting and bookkeeping processes, too much paperwork solely for the grant
- Understanding the constraints of WIOA funding
- Need more time to implement

Survey Highlights

What worked well

- Documentation for students to become WIOA eligible
- New and strengthened partnerships
- Our team's ability to accommodate contract changes
- New awareness of opportunities at multiple grade bands
- New shared visions for this work, systems level coordination
- Youth success stories

Launch funding secured: \$24M operating and \$9.5M capital funding for Career Connect Washington (and supported initiatives)

Category	FY 2019-21 (\$M)	Funding Details
<u>Local Grants</u>	5.4	Competitive grants for <u>program intermediaries, regional networks and coordinators in education service districts</u> to create and expand career-connected learning opportunities statewide
<u>Increased enrollment</u>	3.6	<ul style="list-style-type: none"> • \$3.0M for CTC Career Launch enrollment • \$0.6M for K-12 Career Launch programs via CTE
<u>Equity supports</u>	1.6	\$1.6M dual enrollment scholarship pilot – provides scholarships and textbook vouchers to low-income students enrolled in Running Start and College in the High School*
<u>System start-up</u>	2.9	<ul style="list-style-type: none"> • \$1.6M to K-12 to support CTE course equivalencies and expansion of career connected learning • \$1.2M for data enclave infrastructure • \$0.1M for CCW implementation
<u>Supported Career Launch initiatives</u>	10.6	<ul style="list-style-type: none"> • \$3.4M for CorePlus in K-12 programs • \$2.0M for information technology apprenticeships • \$1.6M for expanding health care apprenticeships • \$1.5M for regional pre-apprenticeship pathways pilot program in Marysville School District • \$0.9M for expansion of state apprenticeship staffing • \$0.7M for controls apprenticeship pathways in South Kitsap School District • \$0.5M biological manufacturing equipment for regional training facility in Bothell
Total Operating Funding	24.1	
Total Capital Funding	9.5	<ul style="list-style-type: none"> • \$4.5M for K-12 equipment grants, of which \$3.5M for skills centers • \$5.0M for CTC equipment grants
Additional: Washington College Grant Program	TBD (Dependent on number of Career Launch students)	<ul style="list-style-type: none"> • \$177M for the Washington College Grant program, providing scholarship aid to low-income students to pursue postsecondary degrees. Career Launch (including Reg. Apprenticeship) students are eligible.*

*Funding not exclusive to Career Launch